

ledix

LED lighting fitting

NAVI

with motion and twilight sensor



The fitting is equipped with a built-in PIR motion sensor and a twilight sensor



Mounting indoor only



Mounting in a Ø60 junction box.

NAVI with a built-in motion and twilight sensor is a high quality LED fitting with decorative and application features. It is used for lighting corridors, passageways and staircases. The motion sensor enables the fitting to switch on after motion has been detected in the detection zone. The twilight sensor enables the lighting fitting to operate only with specific luminous flux density.

The features of the fitting:

- adjusted switching on time in the range of 2 ÷ 35 seconds,
- adjusted twilight switch sensitivity in the range of 2 ÷ 20 lx,
- operation range from 2 ÷ 3 m with a 120° opening angle,
- additional output with a maximum load capacity of 1,5 A, which can be used to add other fittings, for example, in staircases or corridors,
- luminous flux emitted in two planes: the lower and the front
- excellent lighting parameters obtained by applying the highest quality LED diodes by CREE,
- high quality, minimum power consumption and durability estimated to light continuously for five years (~ 40 000 h).

CAUTION:

- Power supplies of ZNP and ZNN series and of ZNM series in 14 V DC version by Zamel are used to supply the fittings.



Application:



stairs



corridors, passageways

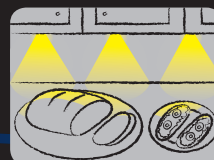

furniture, decorative lighting

A detailed mounting instruction is in the packaging

zameL

LED lighting fitting

NAVI

with motion and twilight sensor



14V DC

ledix



Made in EU

zameL

Zamel Sp. z o.o.
PL 43-200 Pszczyna, ul. Zielona 27, Poland
tel: +48 32 449 15 00, fax: +48 32 449 15 02
e-mail: ledix@ledix.pl, www.ledix.pl

14 V DC; IP20
weight: 131 g



Declaration of Conformity is on www.ledix.pl



The symbol means selective collecting of electrical and electronic equipment. It is forbidden to put the used equipment together with other waste.



Made in EU

11-212 ENG Ver. 04

Lighting Fitting colour



Power / Light colour



www.ledix.pl

TECHNICAL DATA

Supply voltage	14 V DC	
Power consumption	0.78 W – cold white	
	0.64 W – warm white	
	0.50 W – red	
	0.50 W – green	
	0.50 W – blue	
Operating range	maximum 3 m	
Switch on time adjustment	2 ÷ 35 s	
Twilight sensor's sensitivity adjustment	2 ÷ 20 lx	
Colour rendering index R _a	cold white	warm white
	71	80
Colour temperature T _c [K]	5900	3100
Luminous flux Ø [lm]	28	24

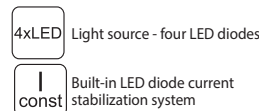
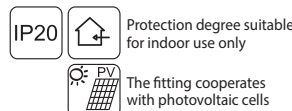

MOUNTING

The device is designed for single-phase installation and must be installed in accordance with standards valid in a particular country. Installation, connection and control should be carried out by a qualified electrician staff, who act in accordance with the service manual and the device functions.

Fitting is designed for mounting in Ø60 junction box.

1. Disconnect power supply by the phase fuse, the circuit-breaker or the switch-disconnector combined to the proper circuit.
2. Check if there is no voltage on connection cables by means of a special measure equipment.
3. Connect the 14 V DC power supply to 230 V AC.
4. Remove the fitting - with the help of fingers hold the control module and move the fitting upward (as shown in the Figure) and gently pull away from the mounting element – if necessary, use a slot drive screwdriver by inserting it into the notch in the casing.
5. Disconnect the connecting cables between the fitting and the control module.
6. Connect the installation cables into the appropriate terminals of the control module in accordance with the selected connection diagram (Figure 1 or 2) maintaining the correct polarity.
7. Mount the control module in a Ø60 junction box and tighten the screws.
8. Adjust the delay switch off time and the luminous intensity by means of a TIME and LUX potentiometer.
9. Connect the fitting cables with the module mounted in Ø60 junction box.
10. Mount the front of the fitting on the mounting element.
11. Switch on the power supply from the mains.
12. Check if the fitting works properly. If necessary correct the adjusted TIME and LUX values.

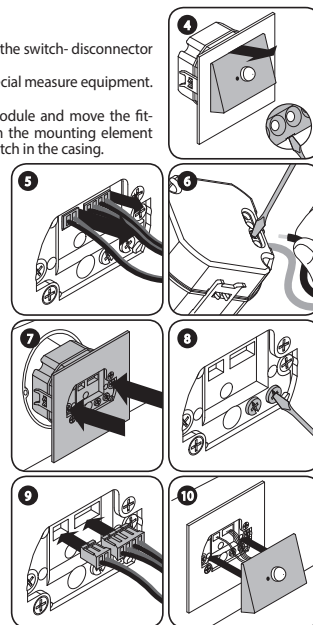
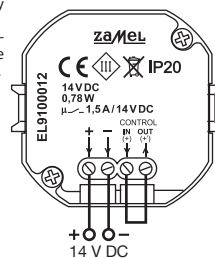

OPERATION

The lighting fitting is equipped with a motion and twilight sensor. The motion sensor is based on the PIR type element and enables to switch on the fitting after motion has been detected in the sensor's detection zone. The fitting is switched on as long as the object is within the area of the motion sensor.

A delayed switch off of a fitting after there is no more motion in the detection zone is adjusted within the range of 2 to 35 seconds according to the TIME potentiometer adjustment.

The built-in twilight switch with an adjustable sensitivity of luminous flux intensity measurement allows a fitting to operate at a given luminous flux. The sensitivity of the twilight switch is adjusted between 2 to 20 lx by means of a LUX potentiometer.

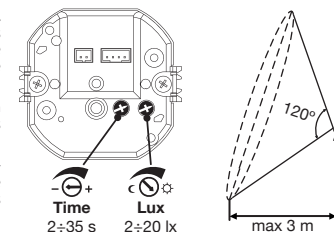

INSTALLATION EXAMPLES

Figure 1.

The lighting fitting is supplied with 14 V DC. After movement detection in the detection zone and at a moment the luminous flux intensity is below the adjusted switching on threshold level (LUX), the voltage '+' on the OUT output of the lighting fitting is switched on. If the voltage is applied to the IN input of the lighting fitting, the lighting source switches on. In case there is no movement in the detection zone, the lighting fitting is switched off with a delay of 2 to 35 seconds depending on TIME potentiometer adjustment.

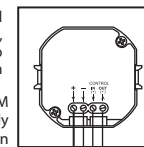
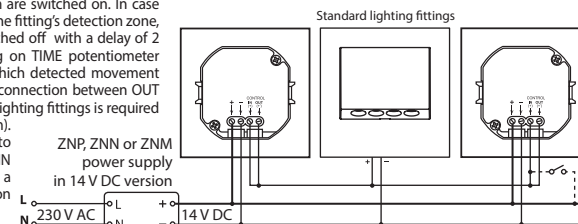

Figure 2.

In this application, it is possible to use any number of lighting fittings with a motion and twilight sensor that cooperate with a standard lighting fittings applied with 14 V DC. All fittings with a motion and twilight sensor are directly supplied with 14 V DC by means of +, - terminals. After movement detection in the detection zone of any fitting with a built-in motion and twilight sensor and at a moment the luminous flux intensity is below the adjusted switching on threshold level (LUX), the voltage '+' is applied to the OUT output of the lighting fitting, which is immediately switched on. All control inputs IN of lighting fittings with a motion and twilight sensor and the supplying input L of the standard lighting fittings are connected to this output. As a result of the above, all fittings connected in this diagram are switched on. In case there is no movement in the fitting's detection zone, the lighting fitting is switched off with a delay of 2 to 35 seconds depending on TIME potentiometer adjustment of a fitting, which detected movement as the last one. The fixed connection between OUT output and IN input of all lighting fittings is required (as shown in the diagram).

Additionally, it is possible to mount a connector to the IN input of any fitting with a motion sensor to switch on the lighting manually.



CAUTIONS

- The motion sensor is positioned in such a way in the fitting as to ensure optimal conditions for motion detection, taking into account the specificity of mounting fittings in passageways, staircases and corridors.
- The fitting is equipped with an additional output with a maximum load capacity of 1.5 A. This output can be used for switching on / switching off any device with a maximum capacity of 1.5 A for 14 V DC. For example, the contact can be used to switch on other fittings in corridors or passageways as shown in Figure 2.
- The operation range of the motion sensor is up to 3 m with a 120° opening angle.
- Avoid mounting the lighting fitting in a perpendicular way in accordance with the movement direction - optimal mounting in the scope of motion detection is shown in the figure.
- After power supply has been applied, wait at least 30 seconds for the PIR sensor operation to stabilize - only after this time proper operation can be checked.
- The fitting, apart from a sensor, is equipped with a twilight sensor - the sensitivity of luminous flux intensity measurement is adjusted in the range from 2 to 20 lx. This allows to accurately adjust the so-called "Twilight level".

