

# VIDEO ENTRY PHONE DISPLAY VP-817B / VP-817W

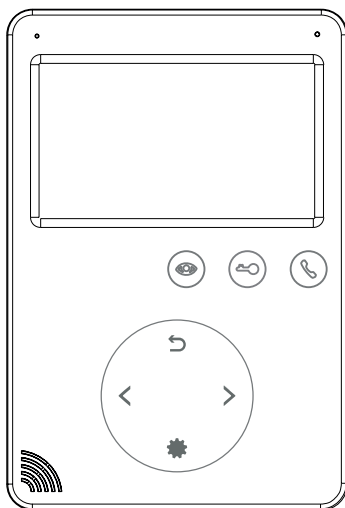

---

Thank you for buying this product from Zamel.  
Zamel shall not accept any liability for any results of damage and/or accidents caused by non-intended use of the product.  
Before attempting installation of this product, please read and understand the entire Operating Manual to comply with the intended use.  
Do not open or tamper with the product without prior authorization.  
Otherwise your warranty rights for this product will be void.

## SAFETY

- Always follow this Manual for your safety and to prevent damage to the product.
- Do not connect more than one load to a single power outlet at a time. Risk of overheating the wiring or fire!
- Do not connect or interface this device with incompatible products. Otherwise there is a risk of an electrical short circuit, resulting in damage to this product.
- Protect the display main board and screen from deformation by any stress. Do not apply heavy loads. Otherwise there is a risk of fire.
- Do not clean the display screen or housing with water or detergents. Risk of damage to the display housing and/or screen, electrical short circuit, and/or fire! Clean the display with a soft, dry cloth made of cotton or microfibre. This will prevent scratching the display screen. Never use toilet paper or tissues.
- Do not install in a highly humid indoor environment. Risk of electrical short circuit and fire!
- Disconnect the power cord from the mains by holding the plug and not the cable. Damage to the power cord cable may result in electric short circuit or a fire.
- Do not plug the power cord to the mains with wet hands. Electrocution hazard!
- Do not attempt to disassemble, repair or alter this product on your own. Risk of electrocution, damage to the product and/or fire!
- Do not install a current breaker on the mains connection of the device. Electrocution hazard!

## PRODUCT DESCRIPTION

- 4.3" colour LCD touch screen
- 4-core wiring
- Intuitive interface
- Digital audio and video recorder (DVR)
- Internal calls (display-to-display intercom mode)
- Public Address mode
- Gate and wicket opening control
- Supports up to two CCTV feeds
- Supports up to two entrance panels
- Calendar mode
- Alarm clock
- Digital photo frame mode
- Media player
- Internal memory for up to 90 digital photos
- microSD card reader: supports up to 32 GB storage
- Gate entrance panel video feed recording and manual camera snapshot functionality
- Leave Message (voice recorder) mode
- Automatic gate entrance panel camera snapshot at each Call button press
- Motion detection and automatic video feed sequence recording
- Automatic Away-from-Home Reply mode

- On-demand video feed monitoring from entrance panels and all connected CCTV cameras
- Two-way voice communication
- High display screen resolution: 800 x 480
- Clear voice handset-free device
- 10-step voice volume control
- 10-step brightness, contrast and saturation control
- 10-step ringtone volume control
- 13 polyphonic ringtones
- Additional ringtones available from a microSD card

## TECHNICAL DATA

- Operating temperature: -30°C to +60°C
- Supply voltage: 110-240 V AC / 50-60 Hz; 14.5 V DC / 0.8 A
- Power input: 9 W (max); 0.7 W (standby)
- Operating RH: 0% to 95%
- Display dimensions: 170 x 116 x 16 mm
- Weight: 206 g

## WIRING PROFILE

- ≤ 50 m (4 x 0.5 mm<sup>2</sup>)
- ≤ 75 m (4 x 0.75 mm<sup>2</sup>)
- ≤ 100 m (4 x 1.0 mm<sup>2</sup>)

## PRODUCT COMPONENTS

- 1 x Display unit
- 1 x Operating Manual
- 1 x Base stand
- 2 x Wall plugs
- 2 x M4 x 30 screws
- 2 x 5-pin male connector
- 1 x 4-pin male connector
- 1 x 4-pin male connector

# WIRING CONNECTION DIAGRAM

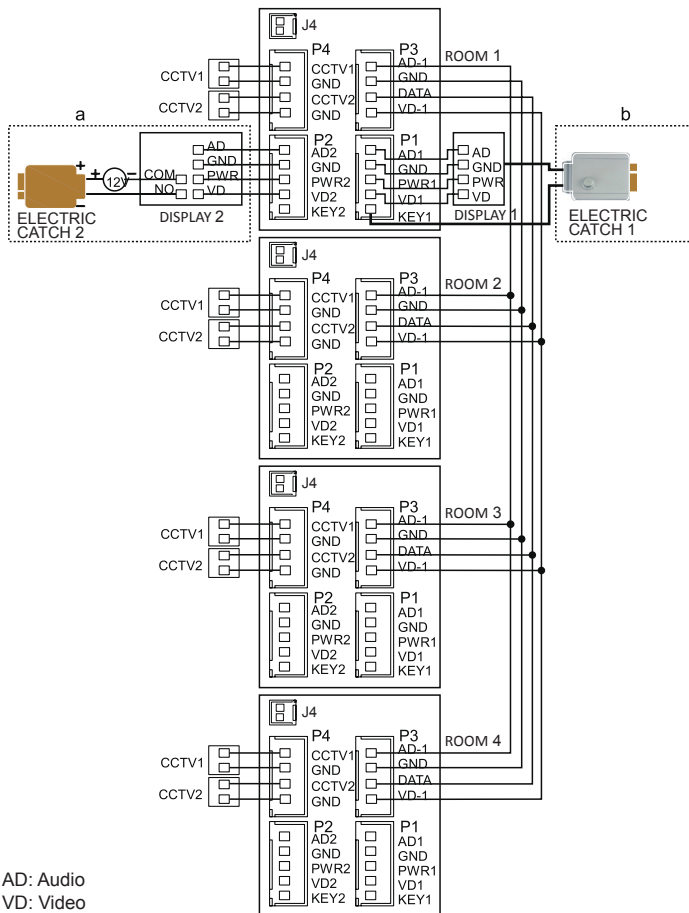

AD: Audio  
 VD: Video  
 PWR: Power  
 GND: Ground  
 DATA: Data communication  
 CCTV: CCTV feed in  
 KEY1/KEY2: Control voltage

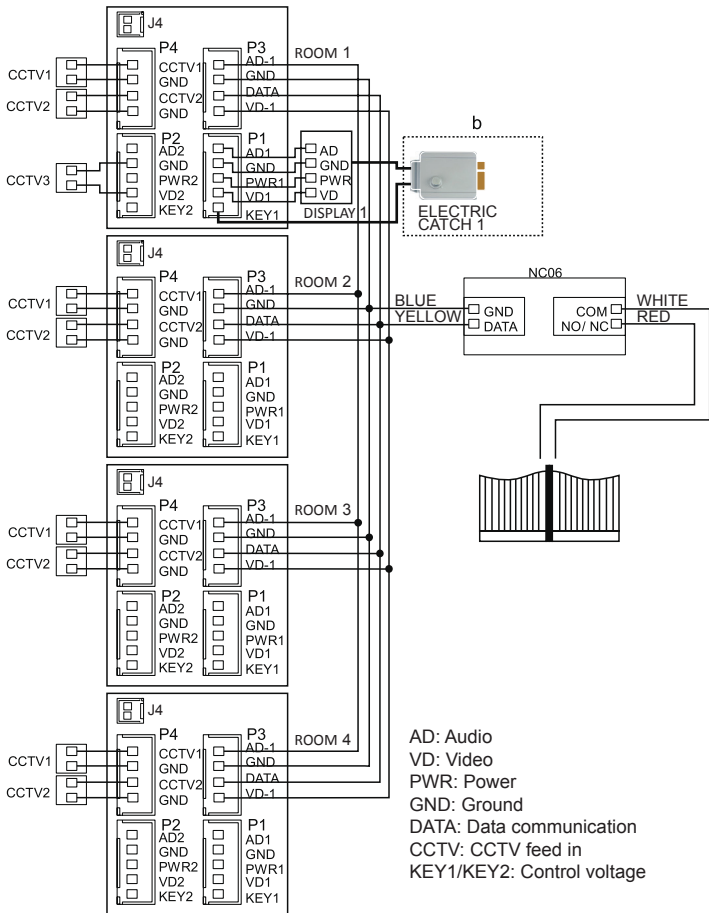

**Note:**

- (a) Wiring connection diagram for an entrance panel with electric catch no. 2 + extra external power supply.
- (b) Wiring connection diagram for electric catch no. 1 with the display output power (GND and KEY1 contacts).
- (c) External power supply port J4 (optional)
- (d) Wiring connection diagram for the NC06 gate control module (Connector P3 GND and DATA to NC06; COM NO/NC to gate control)

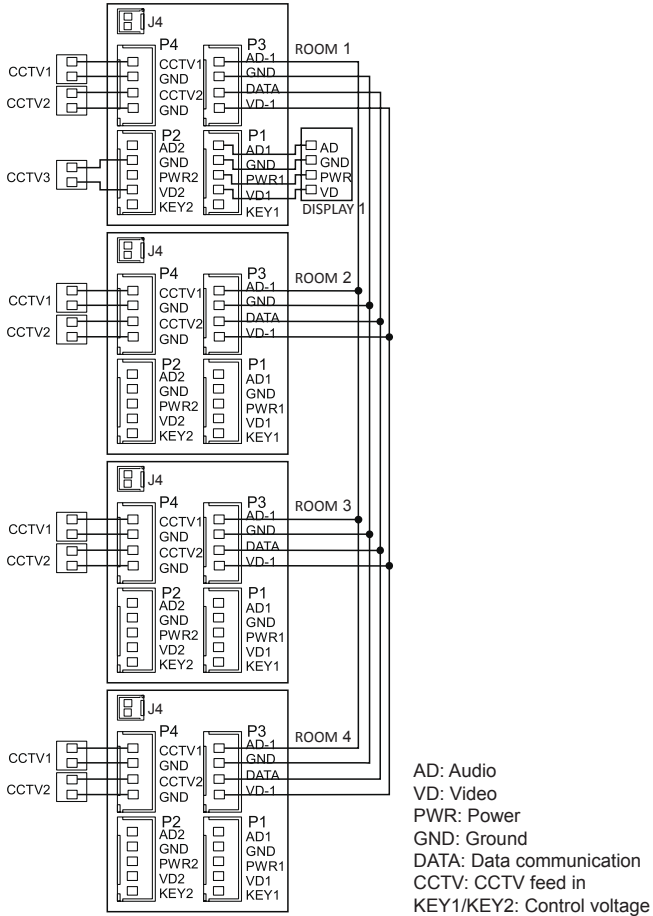

- The second and each additional display may only output the video feeds from the cameras to which they are connected.
- All displays can output the video feed of a CCTV camera connected to the entrance panel port.

## SYSTEM CONFIGURATION

The system can be installed in one of the configurations shown in the diagrams below:

- 2 gate entrance panels + 4 displays + 2 CCTV cameras for each display

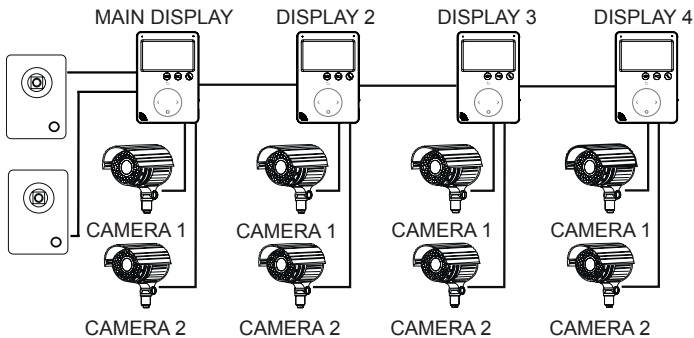

- 1 gate entrance panel + 1 CCTV camera + 4 displays + 2 CCTV cameras for each display

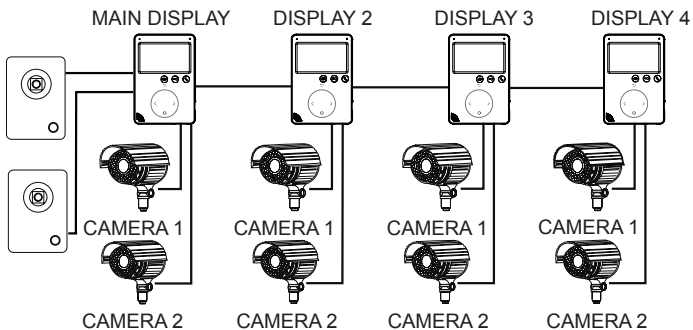

## PRODUCT DESCRIPTION

1. Power On / Off switch
2. Enter Menu / Confirm
3. Speaker
4. Left arrow button: Select / Adjust
5. Back / Hang Up
6. LED indicator
7. LCD
8. Microphone
9. Video feed display
10. Unlock electric catch / gate
11. Answer / Call
12. Right arrow button: Select / Adjust
13. microSD card slot (32 GB max.)

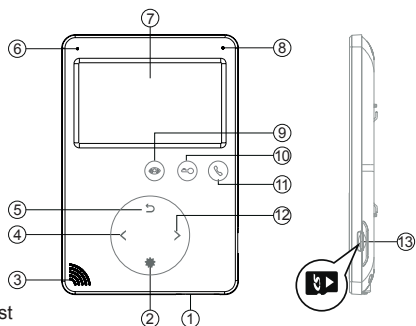

## INSTALLING THE SYSTEM

1. Use the wiring connection diagram for the chosen system configuration and verify that all wiring connections are correct.
  2. Choose a suitable location in which to install the display unit. An installation height between 1.5 and 1.6 m above the ground is recommended.
  3. Verify that the power supply voltage is OFF before wiring the device.
  4. Mount the back frame on the wall at the installation location.
  5. Connect the wiring to the terminals, see the wiring connection diagram for the chosen system configuration.
  6. Install the display unit on the back frame.
- Switch on the supply voltage of the device when completely installed.

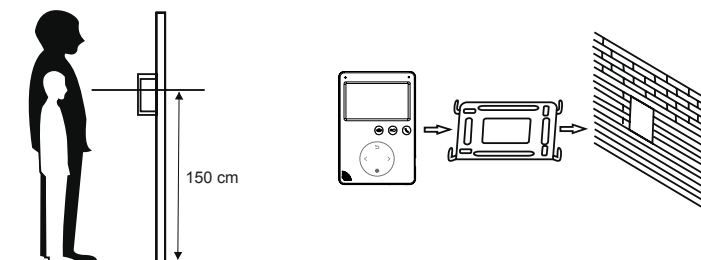



## WIRING SPECIFICATIONS

The system supports two electric catch release configurations: with the open command sent by (i) an entrance panel or (ii) a system display (the display open command output wire must have the shield connected to earth). If the open command is sent by an entrance panel, use this wiring specification:

- If the entrance panel is < 30 m away from the video entry phone display, use YTDYw 4 x 0.5 mm<sup>2</sup> wiring.

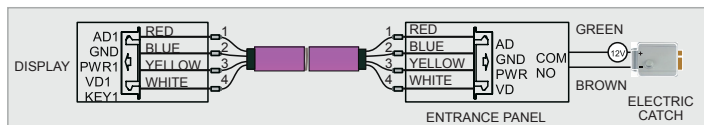

- If the entrance panel is > 30 m away from the video entry phone display, use YTDYw 4 x 0.5 mm<sup>2</sup> wiring.

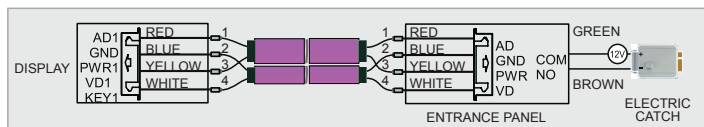

If the open command is sent by a display, use this wiring specification:

- If the entrance panel is < 30 m away from the video entry phone display, use YTDYw 6 x 0.5 mm<sup>2</sup> wiring.

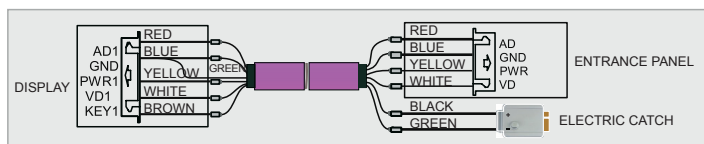



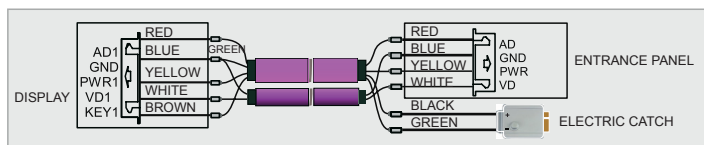





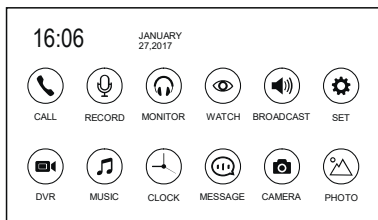









- If the entrance panel is < 30 m away from the video entry phone display, use YTDYw 6 x 0.8 mm<sup>2</sup> wiring.



## MENU OVERVIEW

When the display is in the sleep mode, press  to open the menu shown below:





Item	Icon	Function	Note
1		Call other displays / answer the entrance panel call	
2		Record an away-from-home reply message	
3		Listening mode	
4		Entrance panel / CCTV video feed display	
5		Public Address mode	
6		Settings	
7		Browse and play back DVR files	Touch and hold  to delete a file. Touch and hold  to open the sound settings. Touch and hold the same again to close the settings.
8		Browse and play back media files	
9		Time and calendar display	
10		Browse and play back audio files	Touch and hold  to delete a file. Touch and hold  to open the sound settings. Touch and hold the same again to close the settings.
11		Display snapshots captured by the gate entrance panel	
12		Browse and play back extra photos	Touch and hold  to delete a file.



### Note:

Function items 2, 7, 8, 10, 11, 12 and 13 require a microSD (max. 32 GB) card installed in the display.



## ANSWERING AN ENTRANCE PANEL CALL

When a visitor presses the Call button on the entrance panel, all connected indoor displays will sound the call chime at the same time as displaying the INCOMING CALL message on each display screen.



Touch the  icon to answer the call. Touch  again to send the calling entrance panel camera feed to all other displays. If you touch  before the call is switched by a user of another display in the system, you will return to the calling visitor.

If the call is not answered by the time the call chime stops, the display will enter the standby mode. Touch the  icon to release the electric catch of the calling entrance panel during the call. The display will show DOOR OPEN. Touch and hold the  icon for approx. 2 seconds to open the gate. The display will show GATE OPEN.

If another user calls you during your call, the display will show VISITOR AT DOOR 2. Touch the  icon to answer and switch to the second call.

Note: Touch and hold the  icon during an entrance call or an internal call (display-to-display intercom mode) to mute your microphone. The display will show MUTE. Touch and hold  again to unmute your microphone, which the display will confirm with SPEAK. Operating a gate requires the NC06 gate control module in the system.

## VIDEO FEED MONITORING



With the display on standby, touch  to monitor the video feed from entrance panel no. 1. Touch  again to switch to the next video feed.

The CCTV camera video feeds can only be monitored this way if the Port 4 status is Enabled (see Table SYSTEM SETTINGS, item 5). Touch  to start a voice call with the visitor at the entrance panel from which you are monitoring the video feed.







Touch  to unlock the door of the same entrance panel.

When monitoring the video feed from Door1/Door2/CCTV1/CCTV2, touch and hold  to change the screen aspect from 16:9 to 4:3.

## PUBLIC ADDRESS MODE

The Public Address mode allows you to speak through all displays connected to the video entry phone system. Touch and hold  with the display on standby or  in the Main Menu. The PUBLIC ADDRESS CALL message will be displayed. All other displays in the system will display PUBLIC ADDRESS. You can now speak and be received by other displays in the system.

## INTERNAL CALLS (DISPLAY-TO-DISPLAY INTERCOM MODE)

The intercom mode allows two-way voice calls between two specific displays in the video entry phone system. Touch  on the display on standby to call another display in the system. If you have more than 2 displays in the video entry phone system, choose the display you wish to call with  or . Next, touch  to confirm and make the call. The user at the display being called can touch  to answer the call or  to reject the call.

## MULTIMEDIA

 allows uploading custom music files and voice messages.

## CALENDAR

 displays the time and the calendar.





## MESSAGES

 displays the last events logged by the system.

## PHOTOS

 opens the digital photo frame mode, which displays the photos you have uploaded.



## DISPLAY SOUND VOLUME / BRIGHTNESS / COLOUR / CONTRAST / IMAGE TYPE CONTROL

Touch  or  in the monitoring, incoming call, voice call, intercom, or public address mode to open the sound volume menu. Next, touch  to open the Volume / Brightness / Colour / Contrast / Image Type menu. Operate the controls with  or .

## DO NOT DISTURB MODE

You can enable or disable the DO NOT DISTURB mode in the display System Settings menu. With the display on standby, touch and hold  to enable or disable the Do Not Disturb mode.

## DISPLAY MICROPHONE MONITORING

With the display on standby, touch and hold  to start listening through the microphone of another display in the voice entry phone system. If you have more than 2 displays in the video entry phone system, choose the display you wish to listen to by touching  or  and confirm by touching the icon.

Note:

- The user of the display that is listening will hear everything that the microphone of the display being listened to captures. The display being listened to will not output the sounds captured by the microphone of the display which is listening.
- If you have more than 2 displays in the video entry phone system, verify that the remote listening mode is enabled in the display to which you want to listen. Go to System Settings and verify that Can Be Monitored is set to Enable.

## MANUAL AUDIO RECORDING

Touch  on the main screen; next, touch  to record an audio sequence. Touch  again to stop recording. The recorded files are listed in the Messages menu .

## SNAPSHOT CAPTURE

Manual capturing: Touch  when displaying a video feed from an entrance panel or monitoring a video feed. A snapshot of the video frame will be captured.

The display will show the message IMAGE CAPTURED.

Automatic capture: To have the display automatically capture snapshots, set the AUTO CAPTURE QUANTITY in the System Settings to 1, 2 or 3. The display system will then capture and save the set number of video snapshots to the microSD card when a call is made with an entrance panel.



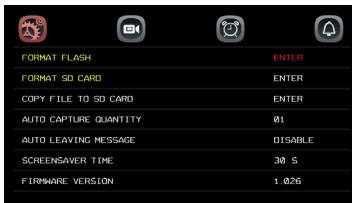

## SYSTEM SETTINGS

With the display on standby, touch  and open the System Settings menu. Next, touch .



## LEAVE MESSAGE MODE

The mode allows each visitor to leave a voice message with the entrance panel when no one answers the call. Activate the mode by setting AUTO LEAVING MESSAGE to Enable in the System Settings. When the Leave Message mode is active, the caller at an entrance panel will hear a recorded Away-from-Home Reply if they press the Call button and the call chime ends unanswered. The Away-from-Home Reply playback will end with a tone, after which the visitor may leave a voice message. The voice message recording time is limited to 20 seconds. The entrance panel will revert to the standby mode after this time has counted down. The default Away-from-Home Reply can be replaced with a custom one you can record on the microSD card.

Item	System functions	Options	Note
1	LANGUAGE	Selects the display interface language.	Choose the language: PL, EN, DE, FR, RU
2	DO NOT DISTURB	ENABLE	The LED will flash if this mode is enabled.
		DISABLE	The mode is disabled by default during a call from an entrance panel, display-to-display intercom (internal) calls and the public address mode.
3	CAN BE MONITORED	ENABLE	This display can be monitored (listened to) by other displays in the video entry phone system if this option is set to ENABLE.
		DISABLE	The mode is disabled by default.
4	OPENING	ENABLE	Touch  to unlock the electric catch linked to the entrance panel. Touch  to open the gate linked to the entrance panel.
		DISABLE	When this function is disabled, touching  followed by  /  will open the door or the gate linked to the entrance panel.
5	PORT STATE	None / CCTV1 / CCTV1&2	
6	DEVICE ADDRESS	Room 1 / 2 / 3 / 4	Choose ROOM 1 on the display that should be the main (master) display of the system. The setting will be yellow if the same device address is set in two displays in the video entry phone system.
7	RESTORE DEFAULT		Restores the default factory settings of this display.
8	FORMAT FLASH		Formats the embedded flash memory of this display.
9	FORMAT SD CARD		Formats the microSD card installed in the display.
10	COPY FILE TO SD CARD		Copies all files from the embedded flash memory to the microSD card in the display.
11	AUTO CAPTURE QUANTITY	01, 02, 03	Automatically captures 1, 2 or 3 video feed snapshots during a call from an entrance panel.

12	AUTO LEAVING MESSAGE	ENABLE	The visitor calling with an entrance panel can leave a voice message after an Away-from-Home Reply and tone.
		DISABLE	Disables this mode.
13	SCREENSAVER TIME		30 s, 1-3 min, 5, 10, 20, 30, 40, 50, 60 min
14	FIRMWARE VERSION		Displays the version of the firmware installed on the display.

## DVR (DIGITAL VIDEO RECORDER)

Touch  to open the Main Menu. Touch the DVR icon.

Touch  to open the DVR Settings.



### Automatic DVR operation:

Set DVR to Enable in the System Settings. DVR can record video sequences from each entrance panel and CCTV camera connected to the video entry phone system. If motion detection is enabled, the system will automatically record a video sequence up to 7 minutes long in a cycle mode. The cycles of video sequence recording are 1 minute + 1 minute + 5 minutes. If a camera detects movement in its field of view, its video feed will be recorded for 1 minute. Next, the video feed is again scanned for motion. If there is no motion detected, the video feed recording stops. If there is motion detected, the video feed is recorded for another 1 minute. Next, the video feed is again scanned for motion. If there is no motion detected, the video feed recording stops. If there is motion detected, the video feed is recorded for another 5 minutes, and then the recording stops. DVR will not work if the microSD card in the display has less than 2 GB capacity. The minimum recommended capacity of the microSD card is 8 GB for the DVR to work smoothly.

Set the Resolution to 640x480 for a high video quality.

If the Begin and End Times have the same setting values, DVR will record without interruption.



## VIDEO SNAPSHOT CAPTURE SETTINGS

Storage type	Resolution	Number of snapshots
Embedded flash memory	640 x 480 / 320 x 240, as set in Resolution	100 snapshots max.
microSD card	640 x 480 / 320 x 240, as set in Resolution	Depends on the microSD card capacity

## DVR RECORDING SETTINGS

microSD card capacity	Resolution	Frame rate
2 GB-32 GB	640 x 480 / 320 x 240, as set in Resolution	2 / 4 / 6 / 8 / 10, as set in Frame Rate

## MANUAL VIDEO FEED RECORDING



When an entrance panel call is incoming, touch and hold  to start recording the video feed from the entrance panel. Touch  again to stop recording.

## DVR SETTINGS

Item	Settings	Options	Note
1	DVR	Enable	DVR is enabled.
		Disable	DVR is disabled.
2	FRAME RATE	2 / 4 / 6 / 8 / 10 frame/s	
3	RESOLUTION	640 x 480 / 320 x 240	
4	MOTION DETECT SENSITIVITY	High / Normal / Low	Detects motion in the camera FOV according to a pre-set sensitivity.
		Disable	No motion is detected.
5	BEGIN TIME	The time the DVR starts recording and detecting motion.	
6	END TIME	The time the DVR stops recording and detecting motion.	
7	RECORD LOCATION	DOOR 1 / DOOR 2 / CCTV1 / CCTV2	The video feed and motion detection signal source for the DVR.



## ALARM CLOCK

Touch in the Main Menu. Touch , and touch  to open the Alarm Clock settings.

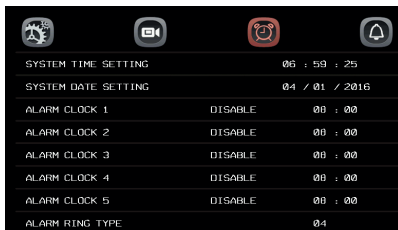

Item	Settings	Options	Note
1		Hour / Minutes / Seconds	
2	SYSTEM DATE SETTING	Day / Month / Year	
3	ALARM RING TYPE	01 – 13	
4	ALARM CLOCK 1 / 2 / 3 / 4	DISABLE	
		ALWAYS ACTIVE	Rings the alarm every day for 1 minute at the pre-set time.
		ACTIVE ON SPECIFIC DAYS	Rings the alarm for 1 minute at the pre-set time on the specific days set.

## CHIME SETTINGS

Touch  in the Main Menu. Touch , and touch  to open the Chime settings.



Item	Settings	Options	Note
1	CHIME TIME	0, 15, 20, 25, 30, 35, 40, 45, 50, 55, 60 s	The chime will stop after the time set here.
2	CHIME VOLUME	00 – 09	00 - Chime muted 09 - Highest chime volume
3	RING TYPE	DOOR 1 / DOOR 2 / INTERCOM	01 – 13
4	RING REPEAT	ENABLE	The ringtone will sound repeatedly for a pre-set time.
		DISABLE	The ringtone will sound once.
5	NIGHT MODE	00 – 05	The ringtone will be automatically muted between 22:00 and 07:00.
		DISABLE	

## ADVANCED SETTINGS

The Advanced Settings can be accessed by pressing and holding  while powering on the display. The Advances Settings include:

- Door unlock time  
1-10; 20, 30, 40, 50, 60, 70, 80, 90, 99 s
- Gate status  
Normally open electric catch contact (NO)  
Normally closed electric catch contact (NC)
- Gate unlock time  
0.2, 0.5, 1-5 s
- System type  
Single-family  
Multi-family

The System Type setting applies to the P1 connector of the display linked to Door 1.

## WARRANTY

24-month commercial warranty by the manufacturer

**Reseller's stamp and signature  
with date of sale**

1. ZAMEL Sp. z o.o. Gives a 24-month warranty for the goods it sells.
2. The warranty given by ZAMEL Sp. z o.o. does not cover:
  - a) mechanical damage caused by transport, loading/unloading or other circumstances;
  - b) damage caused by improper installation or operation of the goods manufactured by ZAMEL Sp. z o.o.;
  - c) damage caused by any modifications made by the BUYER or any third party to the sold goods or to the equipment required for the proper functioning of the sold goods;
  - d) damage caused by any force majeure event or another fortuitous event beyond any reasonable control of ZAMEL Sp. z o.o.;
  - e) the power supply (batteries) included (if any) with the device as sold.
3. The BUYER shall make all warranty claims in writing at the point of sale or to ZAMEL Sp. z o.o.
4. ZAMEL Sp. z o.o. will examine each warranty claim as regulated by the applicable provisions of the Polish law.
5. The form of warranty claim resolution, i.e. replacement, repair or refund of the price of purchase, shall be decided by ZAMEL Sp. z o.o.
6. This warranty does not exclude, limit or suspend any rights of the BUYER arising from the statutory or regulatory laws concerning implied warranty for defects of sold goods.

