

## 4-CHANNEL BUTTON TRANSMITTER WITH TEMPERATURE SENSOR

# RNK-24

### TECHNICAL DATA

Nominal supply voltage:	3 V DC
Battery type:	CR2032
Battery operating life:	2 ÷ 3 years with switched on temperature sensor 3 ÷ 5 years with switched off temperature sensor
Number of channels:	4
Transmission:	radio - ISM 868 MHz band
Transmission way:	One-way - 9600 bps
Coding:	Algorithm based upon 128-bit key
Cooperation:	only with exta life elements
Operating range	to 300 m in the open area
Ambient temperature measuring range:	-40 ÷ +125 °C – it is a complete measuring range of the applied temperature sensor. It is required to obey the recommended operating temperature of the RNK-22 transmitter.
Measuring resolution:	0,1 °C
Measuring accuracy:	±1 °C (type) 0°C ÷ +85°C / ±2 °C (type) -40°C ÷ +125°C
Temperature measuring frequency:	every 15 minutes
Battery charge/discharge optical signalling:	LED green
Temperature operating range:	-10 ÷ +55 °C
Operating position:	free
Casing mounting:	wall plugs, double-sided adhesive tape
Casing protection degree:	IP20 (EN 60529)
Protection level:	III
Pollution degree:	2
Dimensions:	90 x 80 x 11,5 mm
Weight:	0,038 kg
Reference standard:	ETSI EN 300 220-1, ETSI EN 300 220-2

### DESCRIPTION

The RNK-24 wall radio transmitter is used to send control signals and temperature value related information in the extalife system. It is applied to realise the following functions: switching on/switching off, brightening/dimming, roller blind control. The implemented frame coding algorithm increases the safety of the transmission. Temperature value is displayed in the mobile application due to the cooperation of the transmitter with EXTA LIFE controller. The transmitter resembles a common switch due to its appearance and dimensions. The battery backup and lack of wiring allows for its wide application. It means the transmitter can be mounted on any surface (excluding metal surface) and in any place. By assigning a few controllers to one transmitter it is possible to control the device independently from different locations. During operation the LED green informs the transmission is in progress. The LED diode is also used to signal battery discharge.

## FEATURES

- 2-buttons (4-channel) radio transmitter,
- remote control of extalife system receivers,
- possibility of independent control of four receivers,
- coded radio transmission,
- integrated inner temperature sensor,
- temperature measurement realised by means of a sensor:  $-40 \pm +125^{\circ}\text{C}$ ,
- battery powered,
- charge / discharge battery optical signalling,
- easy mounting by means of double-sided adhesive tape or two screws,
- wide operation range (up to 300 m in the open area).

## APPEARANCE

Optical signalling of transmitter's operation

Buttons

Base

Temperature sensor

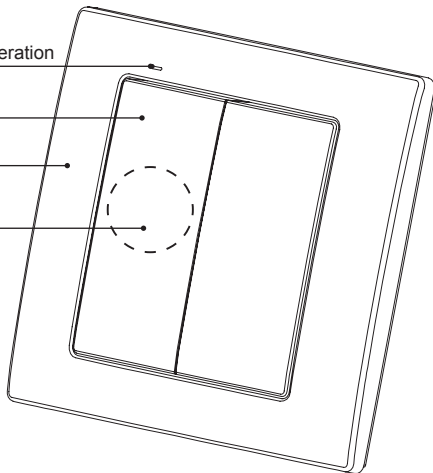

## FUNCTIONING

By pressing the button, the transmitter sends a radio signal to extra life system elements. The above is signalled by a blinking LED green in the transmitter. It is important that the transmitter and the receivers are paired correctly, so that the cooperation between them is undisturbed. Device pairing procedure (adding a transmitter to a receiver's memory) is precisely described in particular EXTA LIFE instruction manual. The transmitter sends a signal only while pushing / releasing the button. In case the button is pushed, the radio signal is not sent. The above protects against quick battery discharge. Whereas temperature value is sent every fifth pressing of any button or automatically depending on current conditions in the mounting place.

## MOUNTING

The RNK-24 transmitter is mounted on walls by means of a double-adhesive tape or wall plugs included in the kit with a transmitter. During mounting it is important to protect the transmitter from water and operation in humid conditions. The ambient temperature during installation should be from  $-10$  to  $+55^{\circ}\text{C}$ .

**While mounting the transmitter with a built-in temperature sensor, it is important to pay attention not to mount the transmitter in direct sunshine or frequent air movements. It must be installed at a proper height.**

Mounting by means of wall plugs:

1. Remove the button - to do it press the button on one side, and on the other side put a screwdriver into a slot and lift up the button.
2. Find a place on the wall to mount the transmitter, make two holes corresponding mounting holes of the transmitter's base.
3. Set wall plugs in the holes.
4. Fix the base by means of screws into wall plugs.
5. Place the button again.

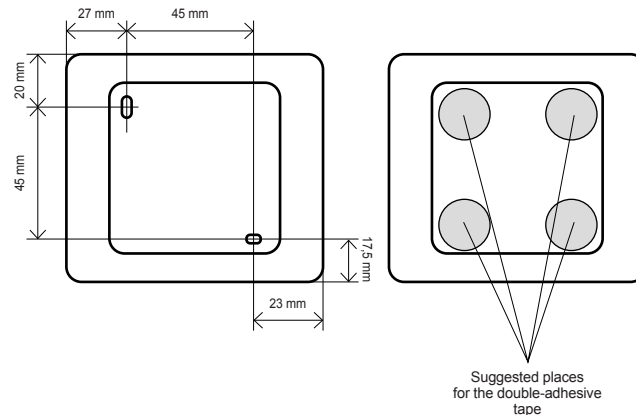

Caution:

- it is best to use 5x(3x30) mm wall plugs,
- optimum double-adhesive tape thickness is 1,2 mm,
- wall plugs and double-adhesive tape are included in the kit with a transmitter.

## BATTERY CHANGE

Battery discharge status is signalled by several LED red flashes during transmission in progress. In case the transmitter is paired with a controller, the battery discharge status is displayed in the mobile application in the form of a message. The transmitter signals the battery must be changed when its voltage drops below the <math>2.1\text{ V}</math> value. The signal is cancelled only after the battery change.

1. Remove the buttons by means of a flat screwdriver (Fig. 1).
  2. By means of a screwdriver lever up the printed-circuit board releasing the bottom latch and remove it from the base (Fig. 2).
  3. Remove the battery from the latch (Fig. 3).
  4. Press any button of the transmitter a few times (to fully discharge).
  5. Mount a new battery. Watch battery polarisation marked on the latch (potential „+“).
- CAUTION: Wrong battery mounting may cause device damage.**
6. Put the removed printed-circuit board back in the base.
  7. Put back the buttons.
  8. Check correct operation – LED diode should switch on in the same way as during transmission.

Fig. 1

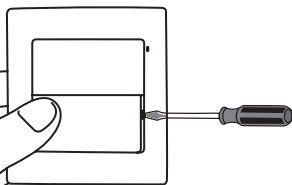

Fig. 2

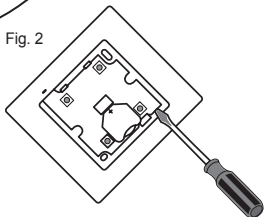
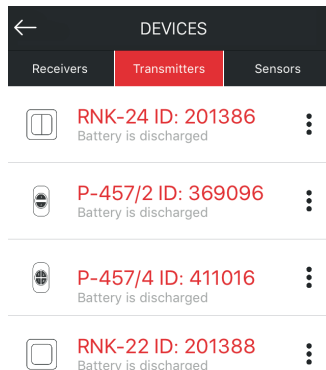
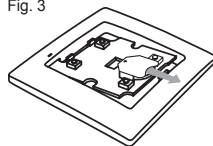

Fig. 3



*Battery discharge status in application exta life.*

## SAFE USE CAUTIONS

### STANDARD FUNCTIONALITY

- standard functionality allows direct control of the extra life system receivers,
- transmitter's button functionality depends on the type of a receiver the buttons have been paired with (for example, when paired with ROP-22 receiver, the buttons can be used to switch on / switch off the lighting and when paired with SRP-22 roller blind controller, the buttons can be used to open / close roller blinds),
- particular buttons can be assigned to a higher number of extra life system receivers at the same time,
- in case one transmitter is to control more than one system receiver, the recommended operation mode is the „switch on / switch off“ mode (one button is used to switch on and the second to switch off),
- it is possible to assign transmitter's buttons to receivers in different modes, which depend on the type of a receiver (details are described in the instruction manuals of extra life receivers),
- in case buttons of one transmitter are assigned to a receiver in time mode, then it is possible to assign individual time in the range from 1 second to 18 hours to each button,
- buttons can be selectively deleted from the memory of receivers

### FUNCTIONALITY WITH CONTROLLER AND EXTA LIFE APPLICATION

Using EXTA LIFE controller and the mobile application it is possible to

- assign remotely (without an access to a receiver) buttons of a transmitter to selected receivers,
- use transmitter's buttons to perform scenes – or as a condition to perform the logic function,
- control battery status in the transmitter,
- read temperature from a sensor built-in a transmitter.

**CAUTION: in order to make use of the functionalities, it is required to pair transmitter with a controller earlier and to register the temperature sensor in the system.**

## TEMPERATURE SENSOR FUNCTIONALITY

Czujnik temperatury zastosowany w nadajniku RNK-24 jest czujnikiem cyfrowym. Umożliwia on pomiar temperatury w zakresie od -40 do +125°C.

### CAUTION:

- **Temperature operating range of the RNK-24 transmitter is between -10 to +55°C, that is why it should not be applied to measure temperature exceeding this range.**
- **Measuring characteristics excludes the application of the sensor in rooms with a dynamic temperature change (the sensor does not register quick temperature changes).**

By default, temperature sensor in the transmitter is switched on. The sensor can be switched off if not used by a user (see Temperature sensor switching on / switching off). Switching off the sensor prolongs the battery life.

### MEASUREMENT CHARACTERISTICS

The sensor measurement differential is set to  $\pm 0.3^\circ\text{C}$  without the possibility of change. Temperature measurement is sent to the controller always after the fifth press of any button of the transmitter with a delay of 5 s (temperature is measured and sent after 5 seconds from the detection of the fifth pressing).

During standard operation, temperature measurement is performed approximately every 15 minutes. The measured temperature (T2) is compared with the previous measurement (T1) and according to the difference of the two values, the current measurement is sent to the controller or not.

$T2 - T1 > 0,3^\circ\text{C}$  – the measurement is sent to the controller to update the value  
 $T2 - T1 \leq 0,3^\circ\text{C}$  – the measurement is not sent to the controller

If the room temperature is stable and changes its value during the next 19 measurements by  $\leq 0.3^\circ\text{C}$  ( $T2 - T1 \leq 0.3^\circ\text{C}$ ), then after performing the twentieth measurement (after around 300 minutes) the temperature is obligatorily sent to the controller to update. Sending temperature after the obligatory time is signalled by a flashing LED in the transmitter.

### SWITCHING ON / SWITCHING OFF TEMPERATURE SENSOR

#### Switching off the temperature sensor

By default, the temperature sensor is switched on in the RNK-24 transmitter. In order to switch it off, carry out the following:

1. Take the battery out of a transmitter.
2. Press button "2" of the transmitter.
3. While pressing button "2" insert the battery into the transmitter.
4. Release button "2" of the transmitter.
5. Temperature sensor is switched off.

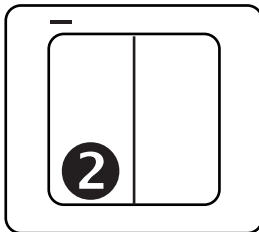

The switched off sensor in the transmitter is remembered even after the battery is taken out. In order to switch it on carry out activities described in "Switching on the temperature sensor".

### Switching on the temperature sensor

In order to switch on the temperature sensor, carry out the following:

1. Take the battery out of a transmitter.
2. Press button "1" of the transmitter.
3. While pressing button "1" insert the battery into the transmitter.
4. Release button "1" of the transmitter.
5. Temperature sensor is switched on.

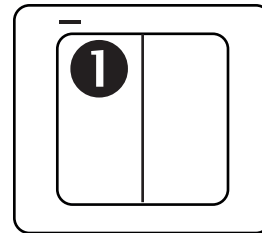

## ADDING TEMPERATURE SENSOR IN EXTA LIFE SYSTEM

Adding a sensor into the extra life system requires the connection of the EXTA LIFE controller and the installation of extalife application in a mobile device.

In order to pair a sensor with a controller the following is required:

1. Start extalife application.
2. Enter the "Device" screen.
3. Choose the "Sensors" tab.
4. Enter the search screen by pressing the "+" button.
5. In time shorter than 60 seconds it is required to press any button of the transmitter 5 times. After that wait for a few seconds.
6. The temperature sensor is registered on the sensor list waiting for pairing with the controller.
7. Before another 60 seconds elapse, the next temperature sensors can be registered or the search process can be stopped by pressing the "Stop" button.
8. After the sensor search is finished, it is required to mark the sensors we want to add in the controller and press the "Pair" button.
9. After the above procedure is finished the sensor is visible in the system and it can show the temperature registered during the pairing process. It is possible to assign a name to the sensor, an icon and use it in the mobile application.

**Caution: The application temperature is updated each time we enter the screen by the sensor or each time we refresh the screen manually (drag the screen downward).**

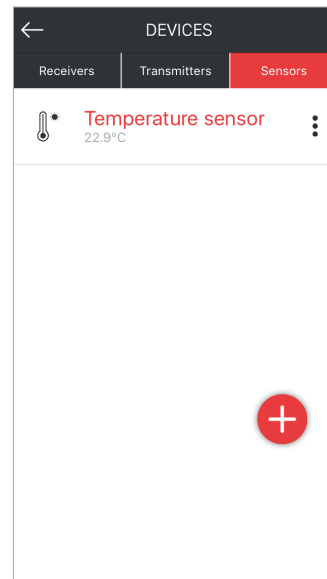

## COOPERATION AND OPERATING RANGE

	ROP-21	ROP-22	RDP-21	SRP-22	EFC-01
<b>RNK-22</b>	280 m	300 m	280 m	300 m	350 m
<b>RNK-24</b>	280 m	300 m	280 m	300 m	350 m
<b>P-457/2</b>	280 m	300 m	280 m	300 m	350 m
<b>P-457/4</b>	280 m	300 m	280 m	300 m	350 m
<b>EFC-01</b>	330 m	350 m	330 m	350 m	-

**CAUTION!** The given range concerns the open area - an ideal condition without any natural or artificial obstacles. If there are some obstacles between a transmitter and a receiver, it is advisable to decrease the range according to: bricks from 10 to 40 %, wood and plaster from 5 to 20 %, reinforced concrete from 40 to 80 %, metal from 90 to 100%, glass from 10 to 20 %. Over- and underground medium and high electrical power lines, radio and television transmitters, GSM transmitters set close to a device system have also a negative influence on the range.