

# ledix

## Electronic transformer 12 V AC 150 W ETW150



zameL

230 V AC

ledix

IP56

**IP56** Protection degree IP: Protection against dust and strong stream of water - demand for a connection with the protection degree IP not lower than IP56



ETW150 transformer with the nominal output power of 150 W is designed to cooperate with halogen light sources supplied with 12 V AC. It has a high level of IP protection, which makes its application possible in places with a strong exposure to humidity (e.g. bathrooms) and outside buildings. ETW150 transformer can supply very low loads (0W) and additionally has a range of protections (against short circuit, overload, thermal) and patented solutions that prolong the lifespan of halogen bulbs and improve their safe use. The connection is done with the use of connection cables. The transformer can cooperate with intelligent types of lighting dimmers.

#### Functions:

- nominal power 0 ÷ 150 W,
- protections against: short circuit, overload,
- long term operation reliability,
- output connection cables of 150 mm.

#### CAUTION:

**The total load power must not exceed 150 W.**

# zameL

Zamel Sp. z o.o.

43-200 Pszczyna, ul. Zielona 27  
tel: +48 32 449 15 00, fax: +48 32 449 15 02  
e-mail: ledix@ledix.pl, [www.ledix.pl](http://www.ledix.pl)

230 V AC / 150 W IP56

weight: 300 g

EN 61347-1, EN 61347-2-2, EN 61547,  
EN 55015, EN 61000-3-2, EN 60598



Electronic transformer 0÷150 W  
TYPE: ETW150



5 903669 053316

 The symbol means selective collecting of electrical and electronic equipment. It is forbidden to put the used equipment together with other waste.



Declaration of Conformity is on [www.ledix.pl](http://www.ledix.pl)

Made in EU

ETW150 GB Ver. 02

[www.ledix.pl](http://www.ledix.pl)

## DESCRIPTION

ETW150 transformer with the nominal output power of 150 W is designed to cooperate with halogen light sources supplied with 12 V AC. It has a high level of IP protection, which makes its application possible in places with a strong exposure to humidity (e.g. bathrooms) and outside buildings. ETW150 transformer can supply very low loads (0W) and additionally has a range of protections (against short circuit, overload, thermal) and patented solutions that prolong the lifespan of halogen bulbs and improve their safe use. The connection is done with the use of connection cables. The transformer can cooperate with intelligent types of lighting dimmers.

## TECHNICAL DATA

Output	
Output voltage:	11,5 V AC
Output power range:	0 ÷ 150 W
Nominal output current:	13 A
Power factor:	0,99
Input	
Nominal supply voltage:	230 V AC
Nominal frequency:	50/60 Hz
Voltage tolerance:	-15% ÷ +10%
Nominal input current:	0,65 A
Other	
Temperature protections:	Yes - returnable $\geq 100$ °C
Short circuit protection:	Yes - returnable
Overload protection:	Yes > 200%Pn
Operating temperature range:	0 ÷ 40 °C
Mounting:	Surface
Casing protection degree:	IP56*
Protection class:	II
Dimensions:	167 x 52,5 x 38,5 mm
Weight:	300 g
Reference standard:	EN 61347-1, EN 61347-2-2, EN 61547, EN 55015, EN 61000-3-2, EN 60598

\* refers to the casing - in order to keep the protection degree it is necessary to perform the connection of IP degree not lower than IP56

## MOUNTING

**CAUTION! The power supply device connection to a single-phase installation must be done in accordance with standards valid in a particular country. Installation, connection and control should be carried out by a qualified electrician staff, who act in accordance with the service manual and the device functions.**

1. Disconnect power supply by the phase fuse, the circuit-breaker or the switch-disconnector combined to the proper circuit.
2. Check if there is no voltage on connection cables by means of a special measure equipment.
3. Connect the output cables in accordance with the connection diagram.
4. Mount the ETW transformer in the desired place.
5. Switch on the power supply from the mains.

- The transformer shall be installed in a place with a good heat abstraction.
- Total power capacity can not exceed the nominal power of the transformer.

## DIMENSIONS

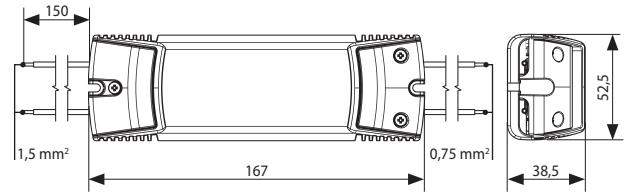

## CONNECTION DIAGRAM

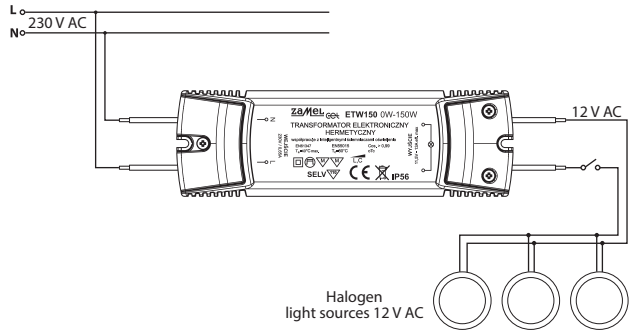

## MOUNTING INDICATIONS

- In case of flush mounting, it is necessary to keep the minimum distances shown in (Fig. 1),
- keep the minimum distance of 30 cm between the transformer and the light bulb or another transformer (Fig. 2),
- output cables must be as short as possible (up to 2 m) and their length for the particular light bulbs must be equal,
- transformers' outputs shall not be connected,
- dimmers must be mounted from the transformer's side (side 230 V AC),
- carry out the connection according to Fig. 4 if there is a big distance between light bulbs and the transformer (power supply must be on both sides of the circuit),
- the wiring must be done in such a way the 230 V AC input cables would not intersect with 12 V AC output cables (Fig. 5).

Transformer	Minimum cross-section of input cables for the nominal load	Total cross-section of output cables for the nominal load
ETW50/60	2 x 0,25 mm <sup>2</sup>	2 x 1 mm <sup>2</sup>
ETW70	2 x 0,4 mm <sup>2</sup>	2 x 1,5 mm <sup>2</sup>
ETW105	2 x 0,5 mm <sup>2</sup>	2 x 1,5 mm <sup>2</sup>
ETW150	2 x 1 mm <sup>2</sup>	2 x (2 x 1,5 mm <sup>2</sup> )
ETW210	2 x 1,5 mm <sup>2</sup>	2 x (2 x 1,5 mm <sup>2</sup> )

Fig. 1

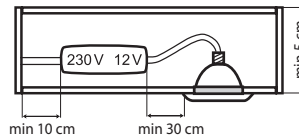

Fig. 2

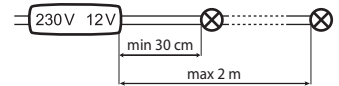

Fig. 3

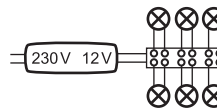

Fig. 4

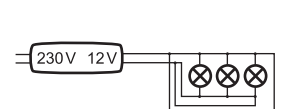

Fig. 5

